

SEMPLICE KB5

semplice®

INSTALLATION MANUAL

Notice:

- Wipe off water after each use with a clean, soft cloth to prevent water spots. Chrome polish can be used.
NEVER use scouring pads or abrasive cleaners with any finish to avoid scratch.
- Never use acid and alkalescent material for cleaning.
- Cartridge and divert are tested in the factory, self disassembly and assembly is not allowed.
- In-floor rough in piece should pass a water test for 30min. under 0.8Mpa before close the tiles, to be sure no water leak.
- In-floor water pipes should be fixed according to the manual strictly, exchange of cold and hot water pipe is not allowed.
- When inside temperature goes to under 0°C, please turn off the water angel valve, open the tap to let water flow out completely.
- In-floor water pipes must be cleaned before tap installation, impurities could damage the cartridge, diverter and aerator.
- CAUTION: when turn on the tap, please turn to cold first, then adjust to suitable temperature, to avoid scald.
- Gloves are needed for installation.

Problems and Solutions:

- If water flow rate is too small, please check the angel valve.
- If water flow is in irregular shape, please check the aerator could have dust.
- If temperature not adjustable, please check the angel valve and connection pipes are correctly installed.

Quality guarantee:

Thank you very much for choosing our products, we will offer full after-sales services. We offer for 2 years limited quality guarantee and whole productlife reparation in terms of:

- Product damage caused by material, manufacture and functional components (not including surface) within 2 years after sales, we offer reparation or same model replacement for free. Customer can return the product only after received our written permission. We will deliver the repaired or replace new product to customer after received the old one. Reparation or replacement depends on the product condition.
- For those products over 2 years after sales, we offer reparation based on cost charge.
- This limited quality guarantee only valid for house and non-commercial usage products.
- This limited quality guarantee does not valid for below terms:
 - use components from outside the factory.
 - wrong installation, usage or maintenance (no matter distributor, plumber or final user).

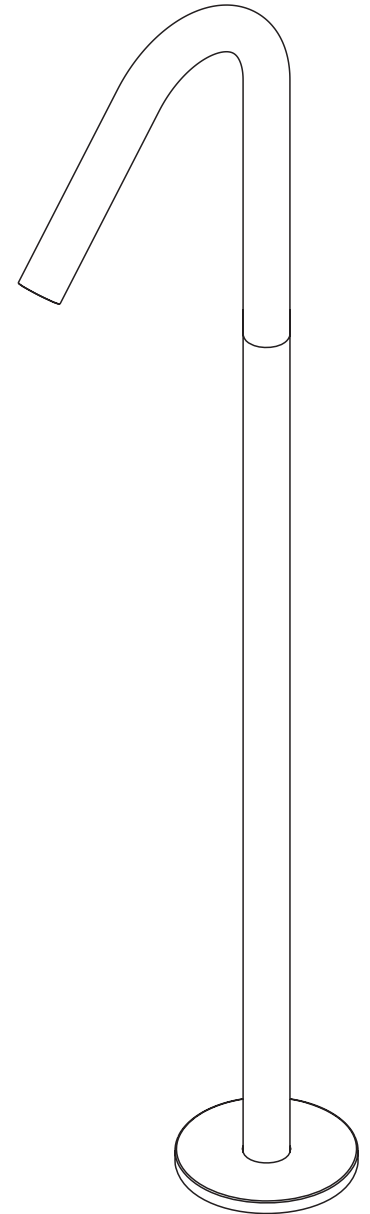

Checking List

	Name	QTY.
1	body	1
2	M5x16 hex bolt	8
3	M5 washer	6
4	rosette	1
5	dust proof cover	1
6	expansion anchor bolts	4
7	plastic box	1
8	water pipe	1
9	Ø24 (ID) x 2.5mm O ring	2
10	Ø24 (ID) x 2.0mm O ring	2
11	water test base	1
12	rubber ring	2
13	rubber water stop	1
14	manual	1
15	S2.0mm hex wrench	1
16	S4.0mm hex wrench	1

specifications:

water pipe thread: G1/2

working pressure: 0.1Mpa~0.5Mpa

working temp.: 3°C ~ 85°C

working material: normal water

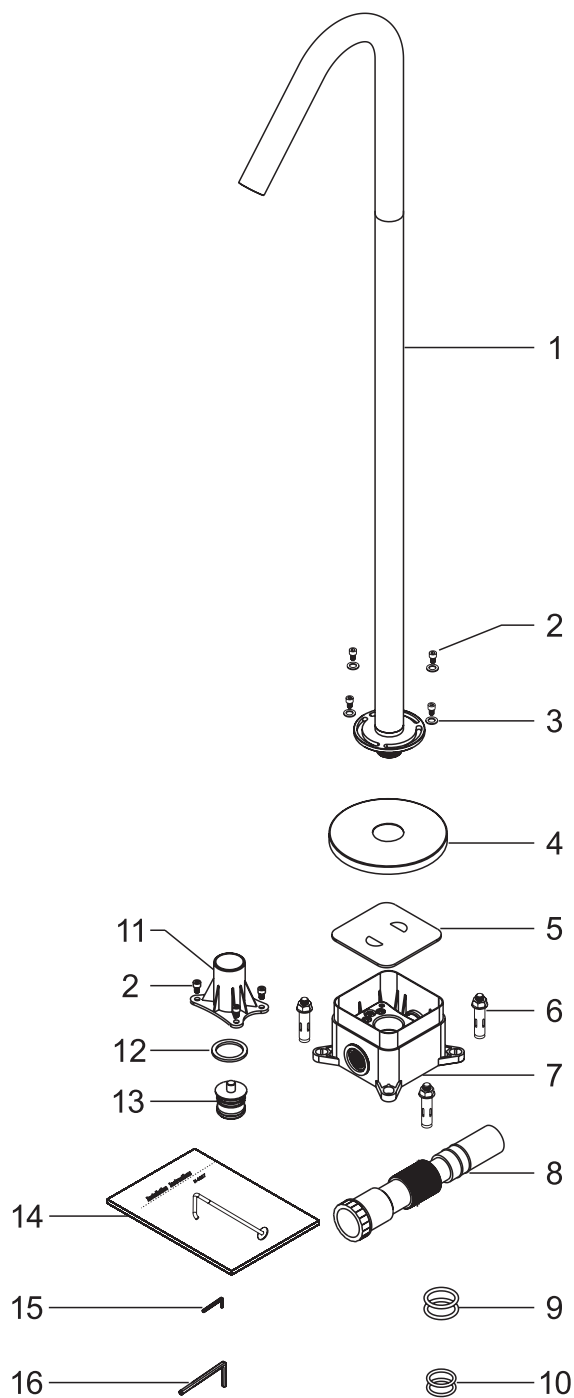

1

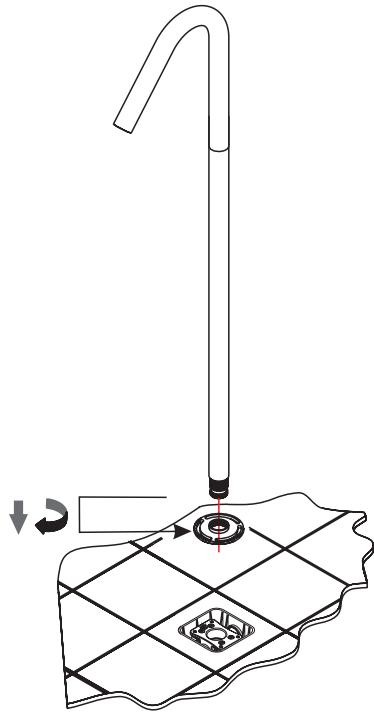

take off the nut from the body.

2

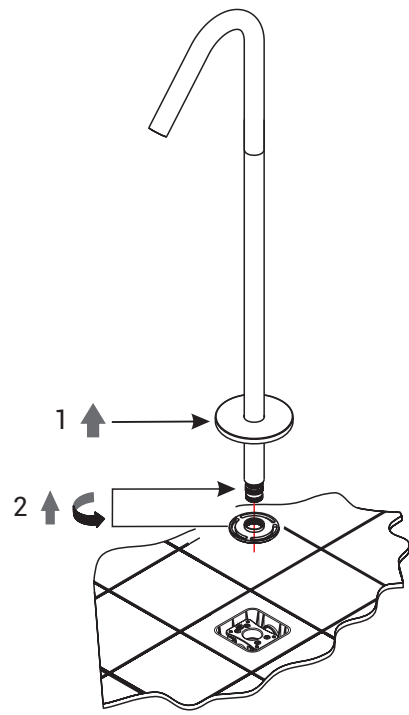

1. Put on the rosette be careful to, avoid scratches.
2. Thread the fixing nut back on the body tightly.

3

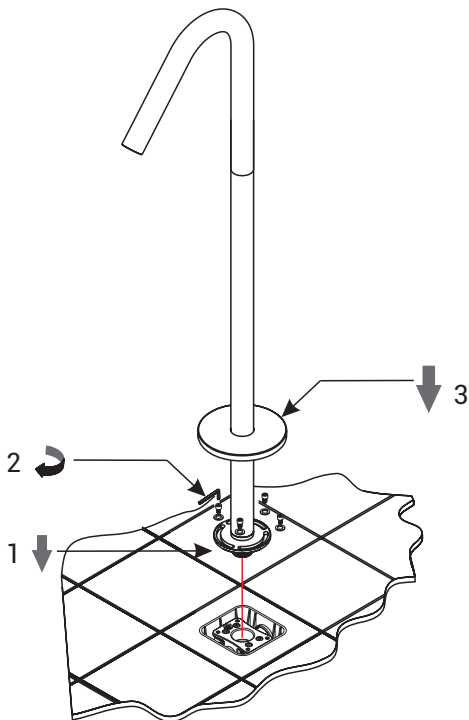

1. Insert the tap to the rough-in box.
2. Fasten the tap by 4 screws.
3. Gently push the rosette down to the ground.

4

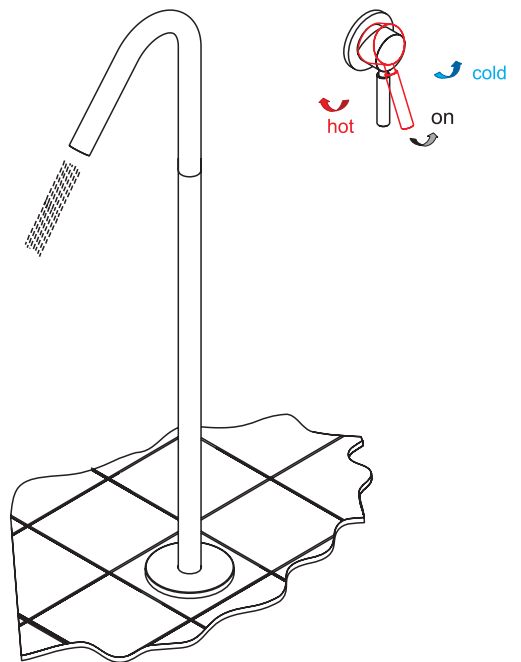

Turn on the tap, turn the handle according to the marks to adjust the temperature.